

# FDES Series Self-Contained Emergency Lighting Units

## Flameproof. Fluorescent

Zone 1 and 2 - 21 and 22  
Gas (G) and Dust (D)

### Applications

- Provides adequate lighting and/or visual indication of access on exit routes during an emergency evacuation in a hazardous environment.
- Can be installed in hazardous areas designated as Zone 1 and 2 – 21 and 22.
- Typical applications include oil refineries, petrochemical plants, pulp and paper mills.

### Features

- Power supply from 110 to 240 Vac 50/60 Hz versions.
- 3-hour duration.
- Threaded access cover with O-ring seal.
- Operates in any position.
- 8 W Fluorescent (1 or 2 lamps supplied).
- Charge indicator by 1 red LED (life time over 10 years).
- Termination 3 or 4 x 2.5 mm<sup>2</sup> terminals.
- Supplied with two fixing lugs.

### Standard Materials

- End caps and cover: aluminum
- O-ring seal: Nitrile
- Lens: tempered borosilicate glass
- Fixing brackets: zinc plated steel or 316 stainless steel
- Accessories: white painted galvanized steel
- Guard: zinc plated steel

### Certifications and Compliances

#### ◆ ATEX/IECEX Certification

- **Certification Type: FLd**
  - Gas: Zone 1 - 2
    - Conforming to ATEX 94/9/CE: Ⓜ II 2 G
    - Type of Protection: Ex d IIC
    - Temperature class: T6
  - Dust: Zone 21 - 22
    - Conforming to ATEX 94/9/CE: Ⓜ II 2 D
    - Type of Protection: Ex tD A21
    - Surface Temperature: T80 °C
  - Ambient Temperature: -40 °C to +55 °C
  - CE Declaration of Conformity: 50203
  - ATEX Certificate: LCIE 97 ATEX 6012
  - IECEx Certificate: IECEx LCI 04.0018
  - Index of Protection according EN/IEC 60529: IP66/68
  - Impact Resistance (shock): IK08
  - Internal Volume: > 2 dm<sup>3</sup>- 2 liters



2 x 8 W Fluorescent Sustained

#### ◆ EURASEC Certification

– EURASEC N° TC RU C-FR.Γ505.B.00912

#### ◆ Others Certification

– INMETRO Certificate: BVC11.0492 ①

① Inmetro certification available on special request only. Contact your local sales for more information

# FDES Series Self-Contained Emergency Lighting Units

## Flameproof. Fluorescent

Zone 1 and 2 - 21 and 22  
Gas (G) and Dust (D)

Order using catalog numbering guide below or select catalog number from tables on following pages.

### Catalog Numbering Guide – FDES Series Self-Contained Emergency Units

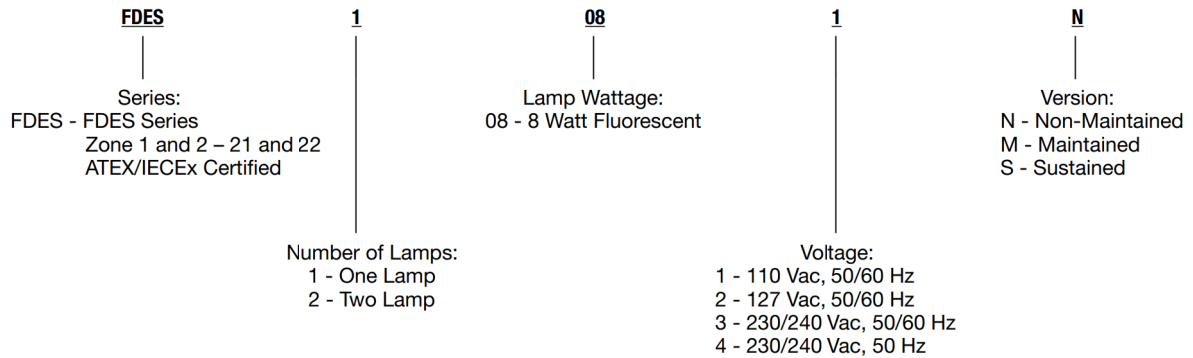

### 3 Hour Duration – Two M20 Threaded Cable Entries With One M20 Blanking Plug

Type	Lumen Output	Voltage	Frequency	Weight kg	Volume dm <sup>3</sup>	Catalog Number
1 x 8 W Fluorescent Non-Maintained	230 lm	230/240 Vac	50/60 Hz	7.8	36	FDES1083N
		127 Vac	50/60 Hz			FDES1082N
		110 Vac	50/60 Hz			FDES1081N
1 x 8 W Fluorescent Maintained	180 lm	230/240 Vac	50/60 Hz	7.8	36	FDES1084M
		127 Vac	50/60 Hz			FDES1082M
		110 Vac	50/60 Hz			FDES1081M
2 x 8 W Fluorescent Sustained	230 lm	230/240 Vac	50 Hz	7.8	36	FDES2084S







Shaded catalog numbers are normally stocked items. All other items are made to order.

# FDES Series Self-Contained Emergency Lighting Units

## Flameproof. Fluorescent

Zone 1 and 2 - 21 and 22  
Gas (G) and Dust (D)

### Accessories and Replacement Parts

	Description	Catalog Number
	<b>Reflector</b> White painted galvanized steel	<b>FDER1G</b>
	<b>Protective Guard</b> Zinc plated steel	<b>FDPG1Z</b>
	<b>Fixing Brackets: Set of two for ease of surface installation</b> Zinc plated steel 316 stainless steel	<b>FDFBZ</b> <b>FDFBS</b>
	<b>Surface Mounting Brackets: Set of two</b> Zinc plated steel 316 stainless steel	<b>FDSBZ</b> <b>FDSBS</b>
	<b>Half Clamps: Set of two</b> Zinc plated steel versions: Diameter for 1-1/4 to 1-1/2" pole: 42 mm to 49 mm Diameter for 2" pole: 60 mm 316 stainless steel versions: Diameter for 1-1/4 to 1-1/2" pole: 42 mm to 49 mm Diameter for 2" pole: 60 mm	<b>FDHC49Z</b> <b>FDHC60Z</b> <b>FDHC49S</b> <b>FDHC60S</b>
	<b>Spare Lamps</b> 8 W fluorescent G5	<b>LF008G5</b>
	<b>Fall Prevention Kit</b> 1.20 m stainless steel chain	<b>FDSCS</b>

Shaded catalog numbers are normally stocked items. All other items are made to order.

# FDES Series Self-Contained Emergency Lighting Units

## Flameproof. Fluorescent

Zone 1 and 2 - 21 and 22  
Gas (G) and Dust (D)

### Electrical Wiring Diagram

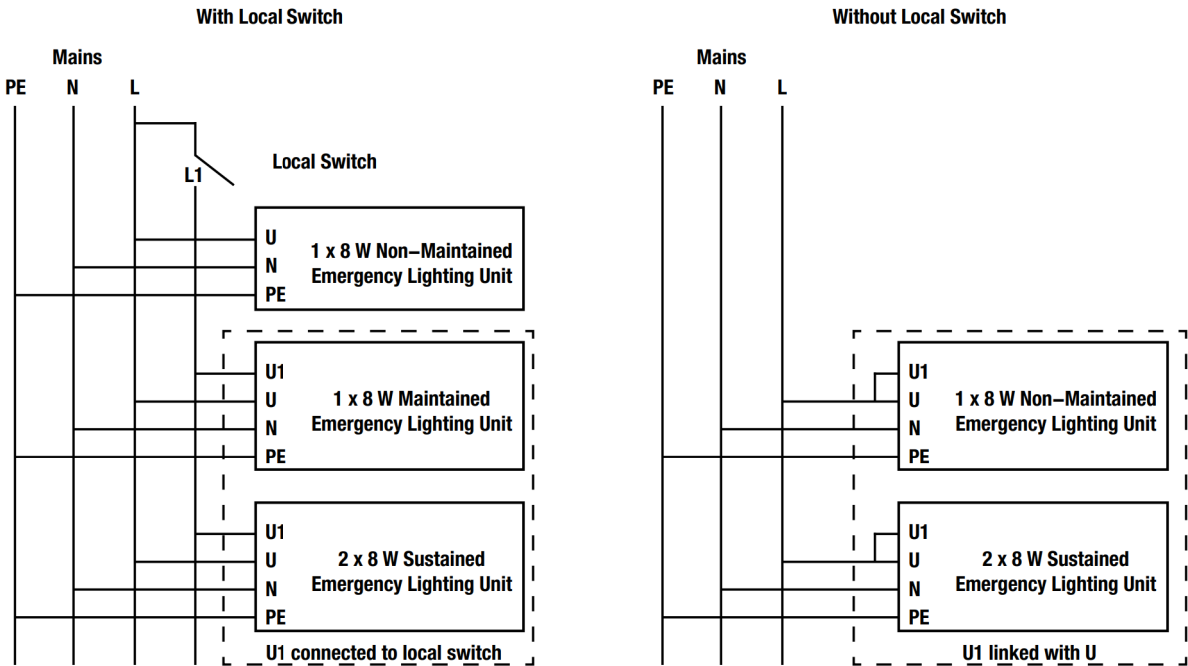

### Emergency Function Diagram

Mains	1 x 8 W Maintained			2 x 8 W Sustained	
	1 x 8 W Non-Maintained	Local Switch OFF or No Link	Local Switch ON or Link Present	Local Switch OFF or No Link	Local Switch ON or Link Present
Switched ON					
Switched OFF					

### Dimensions in Millimeters (Inches)

